

# Anselmi

MEMBER OF SIMONSWERK

Anselmi & C. srl  
 31056 Roncade (Treviso)  
 via Ca' Morelli 19  
 tel. +39 0422 707 426  
 fax +39 0422 840 836  
 www.anselmisrl.it

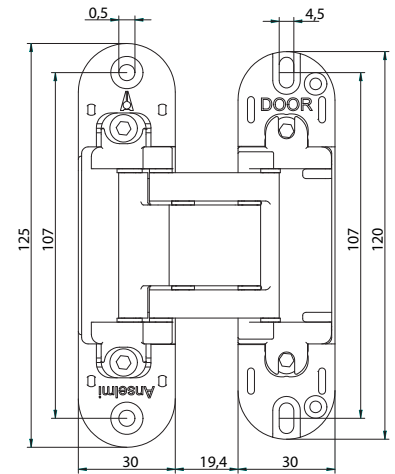
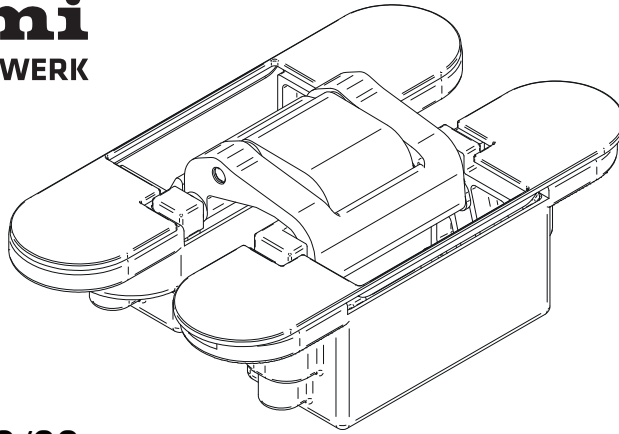

## AN 164 3D FVZ 12/38

DIT\_SP\_040 rev.0 04/12/2020

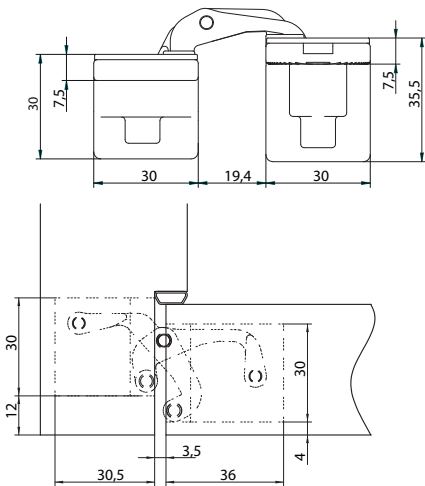

**FRESATURE MILLING**

Stipite Frame

Porta Door

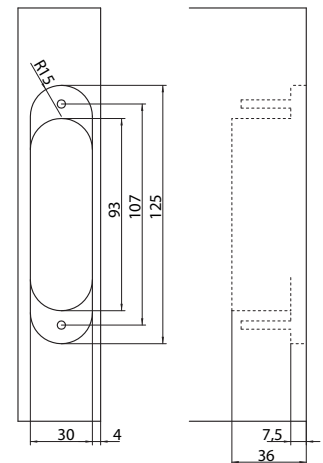
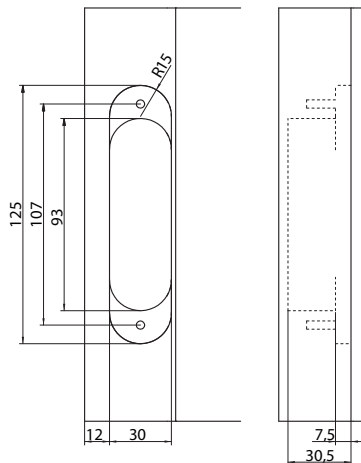

### ISTRUZIONI REGOLAZIONE Adjustment Instructions

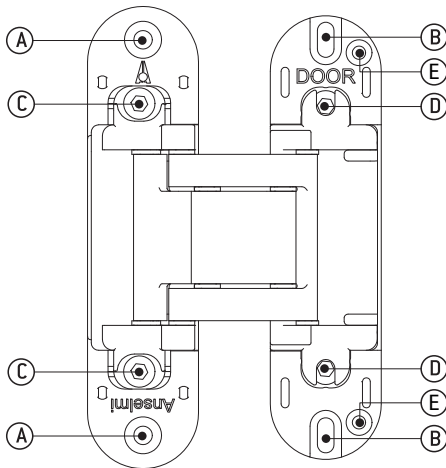

**A** Foro viti di fissaggio della cerniera allo stipite.  
 Fixing hole for the hinge to the frame.

**B** Fori asolati per regolazione verticale e fissaggio alla porta.  
 Oval holes for vertical adjustment and fixing to the door.

**C** Vite di fissaggio regolazione profondità.  
 Fixing screw of depth adjustment.

**D** Vite per regolazione laterale.  
 Screw for lateral adjustment.

**E** Foro per vite opzionale D.3 mm per fissaggio verticale della porta.  
 Hole for optional D. 3 mm screw for vertical fixing of the door.

### Regolazione Altezza Height Adjustment

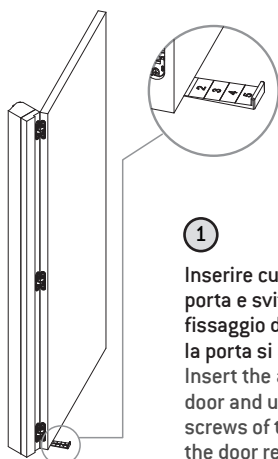

**1**  
 Inserire cuneo di regolazione sotto la porta e svitare di un giro le viti di fissaggio della cerniera sulla porta; la porta si appoggia sul cuneo.  
 Insert the adjustment wedge under the door and unscrew one turn the fixing screws of the hinge on the door; the door rests on the wedge.

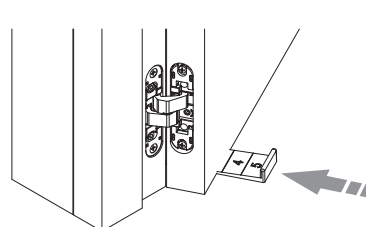

**2**  
 Spingere il cuneo sotto la porta sino a raggiungere la luce da terra desiderata; bloccare nuovamente le viti.  
 Slide the wedge under the door until achieve the desired measure from the ground; re-lock the screws.

## Regolazione Profondità Depth Adjustment

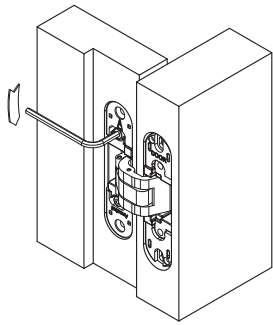

1

Svitare le viti C di un giro.  
Unscrew the C screws one turn.

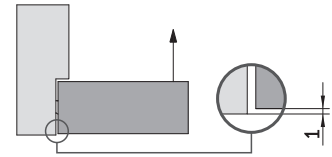

2

Agendo manualmente nella direzione della freccia la porta trasla di 1 mm.  
Acting manually in the arrow direction the door shifts 1 mm.

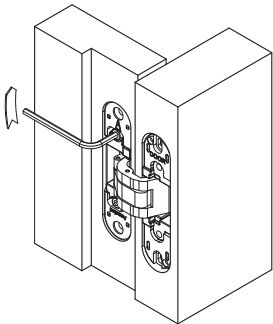

3

Fissare entrambe le viti C.  
Fix the two C screws.

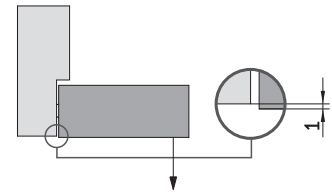

## Regolazione Laterale Side Adjustment

1

Agire sulle viti D.  
Act on D screws.

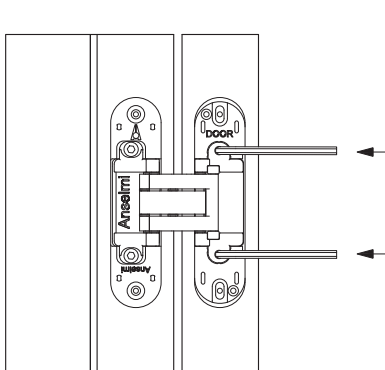

!

Agire sulle viti di regolazione laterale D, agendo in modo alternato ed uguale su entrambe le viti per al massimo un giro completo. Rotate the lateral adjustment screws D, rotating alternately and equally on both screws for a maximum of one complete turn.

2

Agendo sulle viti D in senso orario la porta trasla di - 1,5 mm.  
Acting on the D screws clockwise the door moves to - 1,5 mm.

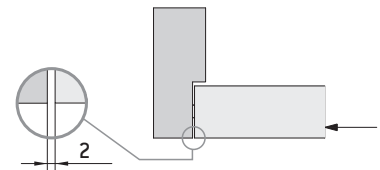

2

Agendo sulle viti D in senso antiorario la porta trasla di + 1,5 mm.  
Acting on the D screws counterclockwise the door moves to + 1,5 mm.

